

TOW WITH

DEMCO[®]



TRAILER COMPONENTS

Brake Actuators4-17
Couplers18-27
Safety Cables/Jacks28
Tongues.....29
Brakes and Brake Line kits30-33
Spare Tire Mounts 34

Home of the
EZ-Latch Coupler
Scan to learn more



Doing Our Best to Provide You the Best
www.demco-products.com • 1.800.543.3626

NEW
30,000 lb
G.V.W.R.

TOW WITH
DEMCO[®]



NEW Gooseneck Couplers



*Round - inner
and Outer Sleeve*

*Square - inner and
Outer Sleeve*

Round

- Assembly fully retracted length = 29.25"
- Assembly fully extended length = 37.50"
- 2 5/16" ball
- 30,000 GVWR
- EZ-Latch coupler
- Black painted inner, raw outer

Square

- Assembly fully retracted length = 29.25"
- Assembly fully extended length = 37.50"
- 2 5/16" ball
- 30,000 GVWR
- EZ-Latch coupler
- Black painted inner, raw outer

DA86

8600 lb
G.V.W.R.

DEMCO[®]



NEW Actuators

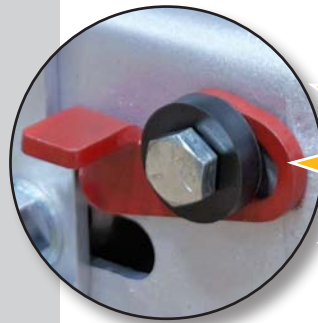

**NEW MANUAL
LOCK-OUT
FEATURE**

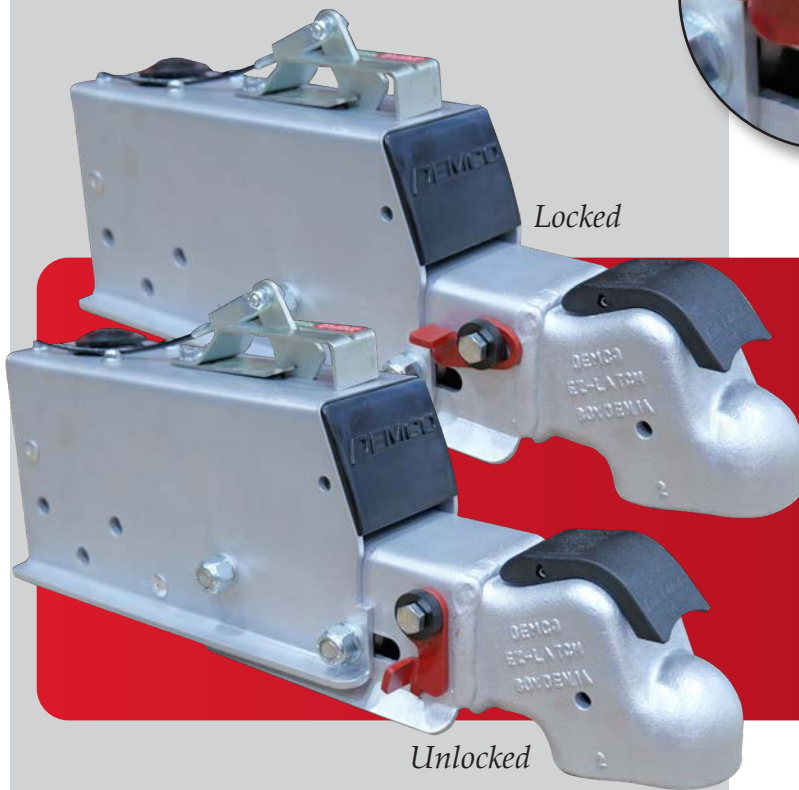

DA86 Hydraulic Brake Actuator

- Utilizes cast head design instead of stamped for easier coupling/un-coupling
- 8,600 lbs. weight capacity is an increase from the 7,000 lbs. on the DA70
- Comes standard with the manual lockout feature, which isn't an option on the DA70
- Riveted spacer plate for increased production rate

DEMCO ACTUATORS

DEMCO®



Hydraulic surge
actuator

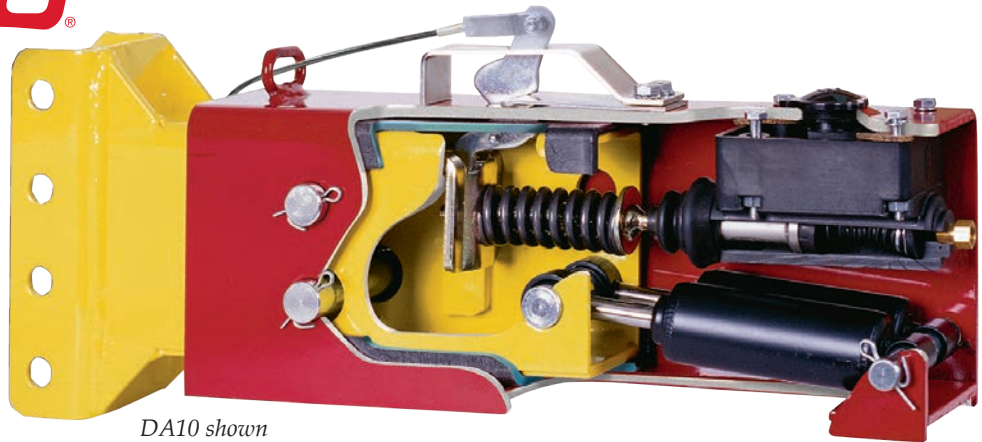

DA10 shown

With industry leading features, Demco Actuators are built heavy duty in the USA for the safest braking and extended trouble-free life.

Available in 7000 lb. to 20,000 lb. G.V.W.R. models.

FEATURES

- Diaphragm in master cylinder cap provides completely enclosed system
- Raised fill plate prevents intrusion of contaminants when removing cap
- Tie loops on cap allow for tethering, creating a tamper-proof seal
- Bellow boot on push rod for more resistance to moisture and contaminants
- Color-coded decal on emergency lever allows quick glance if brakes are on or off
- Actuators fit standard 3" tongues - 4" is available as an option
- 50° A-frame mounts available
- Acetyl Copolymer liners eliminate reliability issues with rollers
- Line pressure controlled by spring loaded push rod
- Integrated shock dampening design
- Emergency cable is attached with a new clevis for easy replacement in the field
- Finishes include Silver Metallic, Black, Zinc and Primed for corrosion-free operation
- Standard master cylinder on all actuator models are made of long glass reinforced nylon. Rust and corrosion are eliminated.
Anti-splash baffle deflects the brake fluid "geyser effect" when bleeding system
New composite master cylinder retrofits previous models without modification
- DA20 disc brake actuators have an optional 1-1/4" bore aluminum master cylinder and heavy-duty push rod assembly for higher line pressures required for 3 or more axles



Slide Kit



Composite Master Cylinder

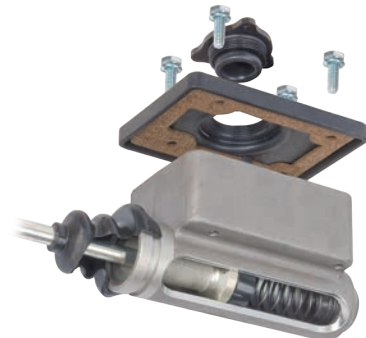

Aluminum Master Cylinder

DEMCO ACTUATOR CONFIGURATIONS

COUPLER CHANNEL AND COUPLER POSITIONS

Channel Down

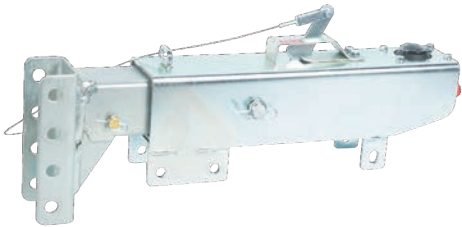

Channel Center

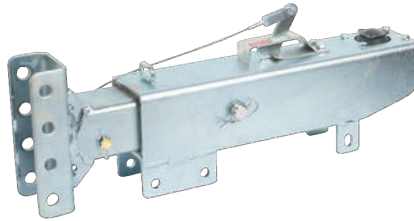

Channel Up

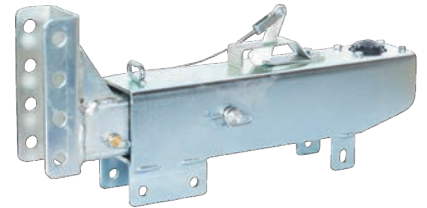

OUTER CASE CONFIGURATIONS

3 Hole Straight

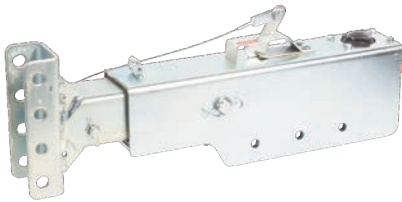

3 Hole Standard

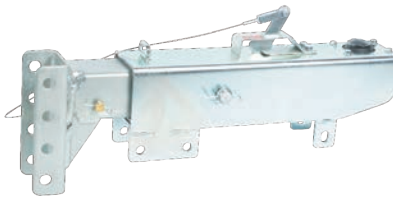

3 Hole

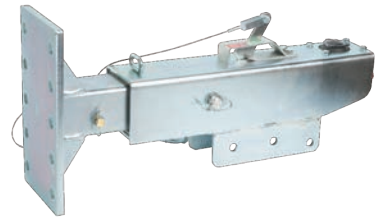

2 Hole

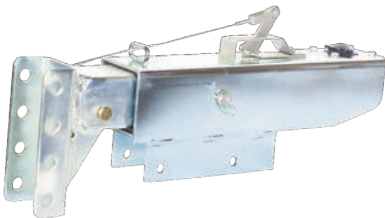

Weld On with Tube Mounts

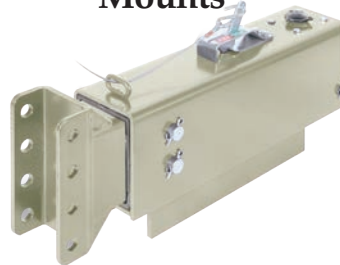

50° Mount



5 Hole

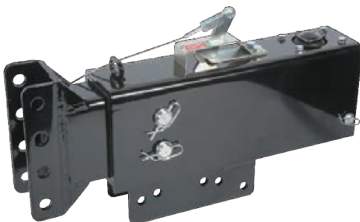

Weld On - No Mount

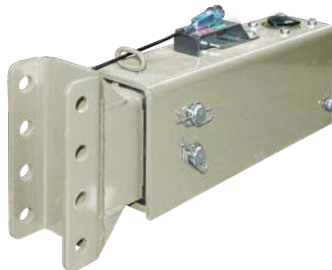

With Angle Mounts

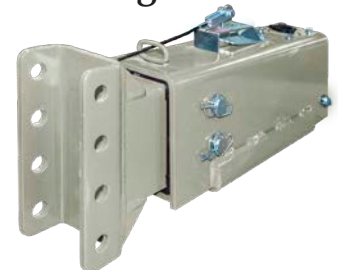

DEMCO FINISHES



Silver: -52
Powder coated

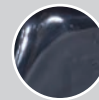

Black: -81
Powder coated



Zinc: -95
Plated zinc



Primed: -97
Powder coated

DEMCO ACTUATOR MOUNTING PATTERNS

3 Hole Standard

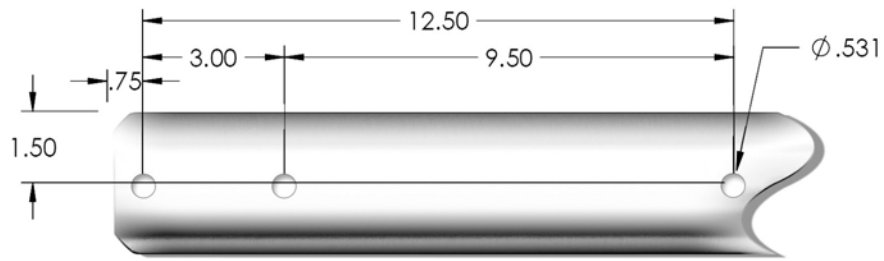

DA70 & DA86 Mount

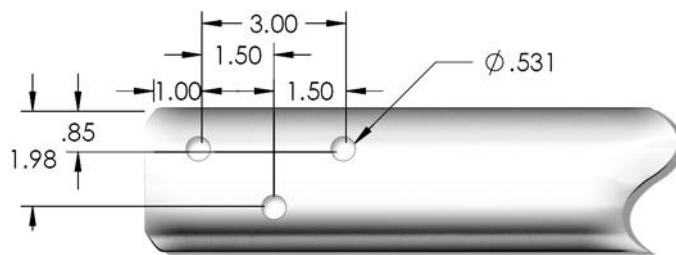

2 Hole Standard

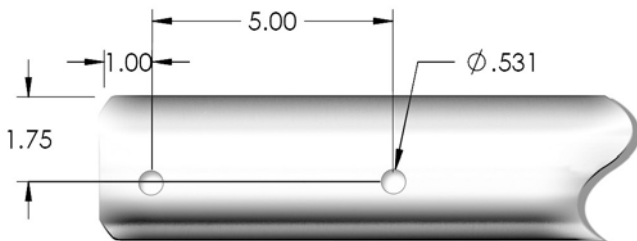

5 Hole Standard

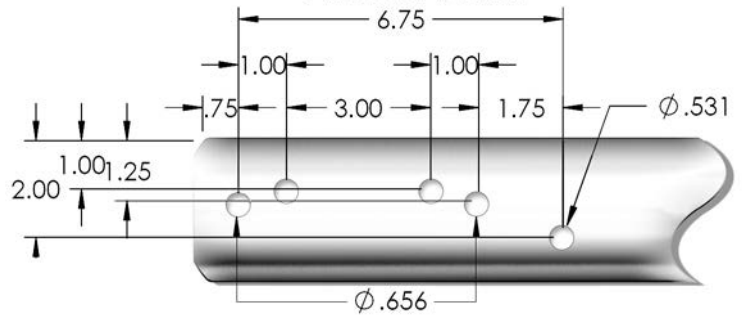

3 Hole

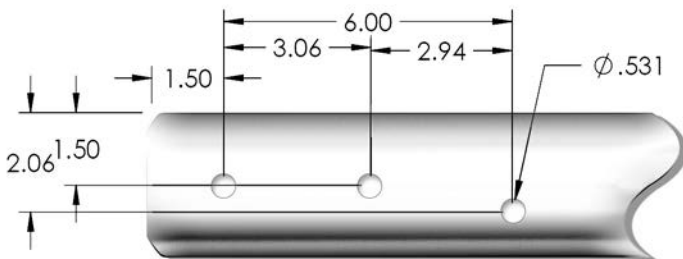

3 Hole Straight

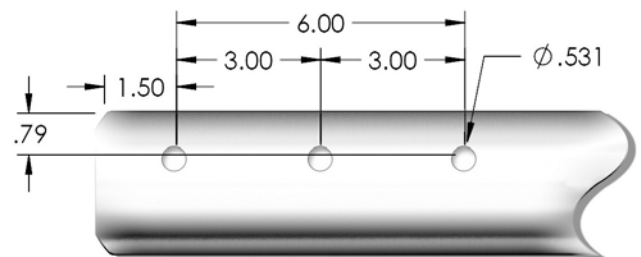

ACTUATORS

2" EZ-LATCH

ITEM #	POSITION	OUTER CASE	FINISH	NOTES	WT (LBS.)
8705001	Center	3 Hole	Zinc		21



8705001

**DRUM
BRAKE**

DA70

**7000 LB.
G.V.W.R.**

2" EZ-LATCH

ITEM #	POSITION	OUTER CASE	FINISH	NOTES	WT (LBS.)
8705101	Center	3 Hole	Zinc		21
8705201	Center	3 Hole	Zinc		21



8705101

**DISC
BRAKE**

DA70

**7000 LB.
G.V.W.R.**

INLINE SOLENOID KIT FOR DISC BRAKES *(fits DA70 actuators)*

5836	DA70	Solenoid Kit	2
------	------	--------------	---

2" EZ-LATCH

ITEM #	POSITION	OUTER CASE	FINISH	NOTES	WT (LBS.)
8668601	Center	3 Hole	Zinc		21

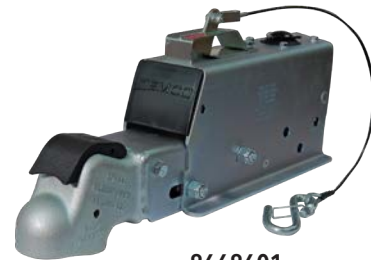

8668601

**DRUM
BRAKE**

DA86

**8600 LB.
G.V.W.R.**

2" EZ-LATCH

ITEM #	POSITION	OUTER CASE	FINISH	NOTES	WT (LBS.)
8668611	Center	3 Hole	Zinc	w/ Inline Solenoid	21
8668621	Center	3 Hole	Zinc	w/ Manual Lockout and Inline Solenoid	21
8665611	Center	3 Hole	Zinc	w/ Manual Lockout, Inline Solenoid, and Custom Solenoid Cover	21



8668611

**DISC
BRAKE**

DA86

**8600 LB.
G.V.W.R.**

ACTUATORS

**DISC
BRAKE**

DA91

**8000 LB.
G.V.W.R.**

2" EZ-LATCH

ITEM #	POSITION	OUTER CASE	FINISH	NOTES	WT (LBS.)
8669113	Down	3 Hole Standard	Zinc		42

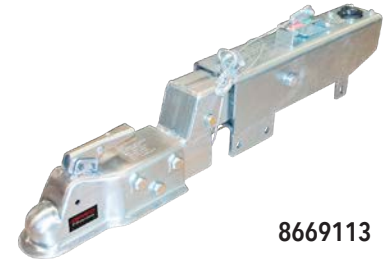

8669113

2 5/16" EZ-LATCH

ITEM #	POSITION	OUTER CASE	FINISH	NOTES	WT (LBS.)
8758811	Down	3 Hole Standard	Zinc		58
8750411	Down	5 Hole Standard	Zinc	Bypass	41

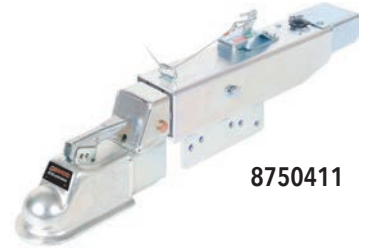

8750411

8" 4 BOLT CHANNEL *(coupler not included)*

ITEM #	POSITION	OUTER CASE	FINISH	NOTES	WT (LBS.)
8758721	Center	3 Hole Standard	Zinc		39
8759422	Center	3 Hole Standard	Primed	Inline Solenoid	39

2" SLIDE-LOK

ITEM #	POSITION	OUTER CASE	FINISH	NOTES	WT (LBS.)
8509202	Center	3 Hole Standard	Primed		43
8509602	Center	50° Mount	Primed		62
8509612	Down	50° Mount	Primed		57



8509202



8509612

2" EZ-LATCH

ITEM #	POSITION	OUTER CASE	FINISH	NOTES	WT (LBS.)
8609502	Center	50° Mount	Primed		54
8609101	Center	3 Hole Standard	Zinc		37
8669112	Down	3 Hole Standard	Zinc		42

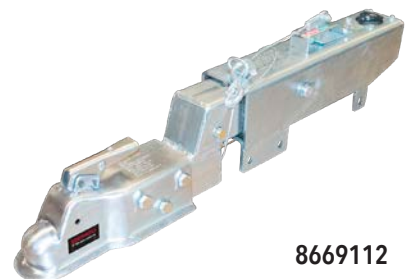

8669112

Custom mounting available upon request (50 quantity minimum)

**DRUM
BRAKE**

DA91

**7000 LB.
G.V.W.R.**

**DRUM
BRAKE**

DA91

**8000 LB.
G.V.W.R.**

**DRUM
BRAKE**

DA91

**8000 LB.
G.V.W.R.**

2 5/16" SLIDE-LOK

ITEM #	POSITION	OUTER CASE	FINISH	NOTES	WT (LBS.)
8759802	Center	50° Mount	Primed		50
8759812	Down	50° Mount	Primed		60



8759812

2 5/16" EZ-LATCH

ITEM #	POSITION	OUTER CASE	FINISH	NOTES	WT (LBS.)
8759411	Down	3 Hole Standard	Zinc		58

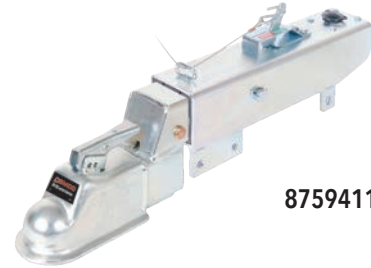

8759411

FLAT PLATE *(coupler not included)*

ITEM #	POSITION	OUTER CASE	FINISH	NOTES	WT (LBS.)
8759152	Center	3 Hole Standard	Primed		39
8759153	Center	3 Hole	Zinc		40
8759552	Center	50° Mount	Primed		53

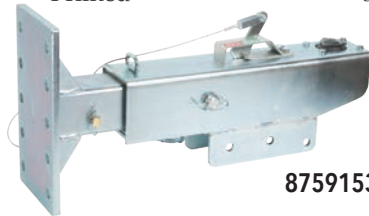

8759153

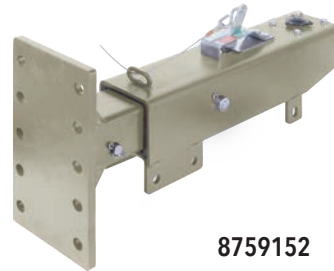

8759152

12" 6 BOLT CHANNEL *(coupler not included)*

ITEM #	POSITION	OUTER CASE	FINISH	NOTES	WT (LBS.)
8758521	Center	3 Hole Standard	Zinc		35
8759432	Down	Weld On	Primed	.024 Orifice	35

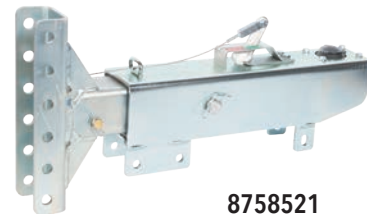

8758521

DA91 MANUAL LOCKOUT

5939	DA91	Manual Lockout Kit (field installed)	25750
------	------	--------------------------------------	-------

BYPASS SOLENOID KITS FOR DRUM BRAKES

5751	DA91	Solenoid Kit
------	------	--------------

DRUM BRAKE CONVERSION

CONVERTS ANY DRUM BRAKE ACTUATOR TO DISC

ITEM #	DESCRIPTION	WT (LBS.)
6116	DA91 Changes standard master cylinder to disc brake with a bypass (factory installed only)	2

ACTUATORS

**DRUM
BRAKE**

DA91

**8000 LB.
G.V.W.R.**

8" 4 BOLT CHANNEL (coupler not included)

ITEM #	POSITION	OUTER CASE	FINISH	NOTES	WT (LBS.)
8759231	Down	2 Hole	Zinc		52
8759241	Up	2 Hole	Zinc		52
8760011	Center	3 Hole Straight	Zinc	Lock Out	35
8760012	Center	3 Hole Straight	Silver	Lock Out	39
8759522	Center	50° Mount	Primed		45
8759532	Down	50° Mount	Primed		53
8759922	Center	Weld On	Primed		30
8759933	Down	Weld On	Primed	Lock Out	32
8759942	Up	Weld On	Primed		39
8759121	Center	3 Hole Standard	Zinc		32
8759122	Center	3 Hole Standard	Primed		32
8759122-30	Center	3 Hole Standard	Black		32
8759131	Down	3 Hole Standard	Zinc		32
8759132	Down	3 Hole Standard	Primed		32
8759138	Down	3 Hole Standard	Black		34
8759142	Up	3 Hole Standard	Primed		38

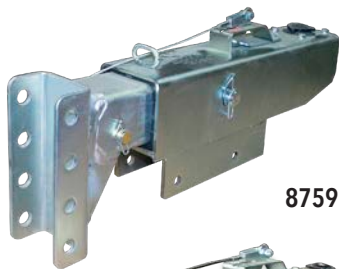

8759231



8759522

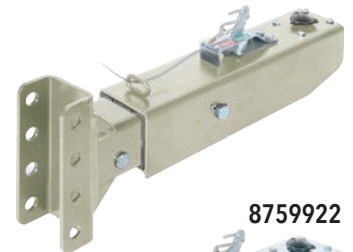

8759922

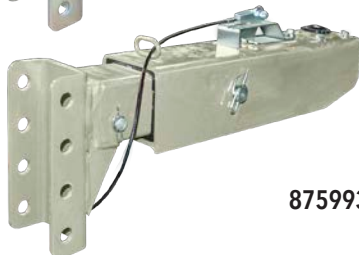

8759933

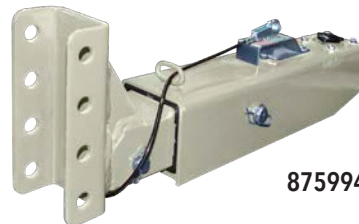

8759942

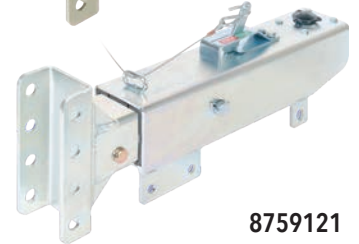

8759121

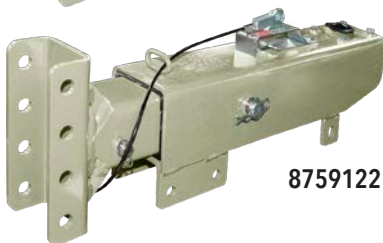

8759122

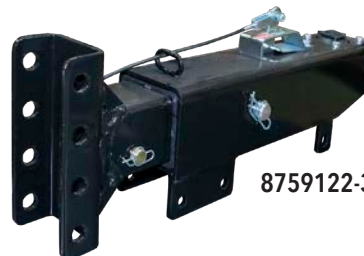

8759122-30

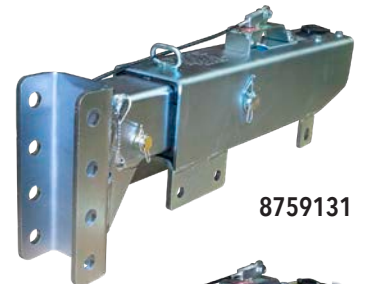

8759131

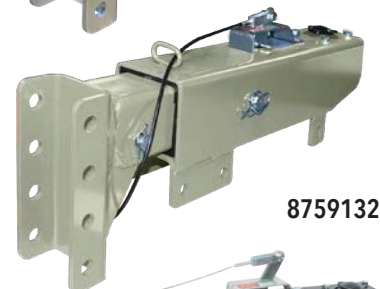

8759132

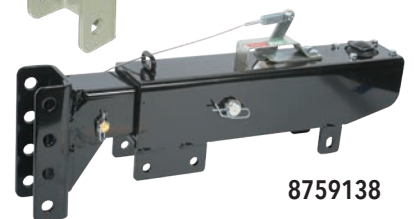

8759138

BYPASS SOLENOID KITS FOR DISC BRAKES (fits DA91 and DA10 actuators)

5752	DA91	Solenoid Kit (factory installed)	2
5750	DA91	Solenoid Kit (field installed)	2

BLOCKING SOLENOID KIT FOR DISC BRAKES (fits DA91 and DA10 actuators)

5837	DA91	Solenoid Kit (field installed)	2
------	------	--------------------------------	---

Note: Solenoid kit design is subject to change at Demco's discretion.

2 5/16" EZ-LATCH

ITEM #	POSITION	OUTER CASE	FINISH	NOTES	WT
8104002	Center	Weld on	Primed	Bypass	54
8104311	Down	5 Bolt Universal	Zinc	Bypass	56
8414311	Down	5 Bolt Universal	Zinc	Inline w/ Manual Lockout	57
8415311	Down	5 Bolt Universal	Zinc	w/ Manual Lockout, Inline Solenoid, and Custom Solenoid Cover	57

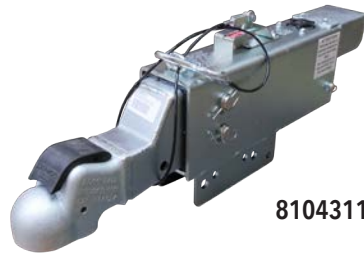

8104311

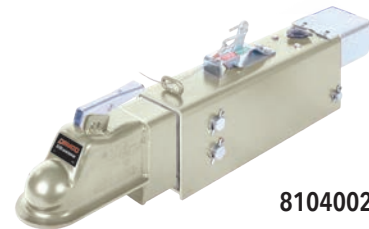

8104002

8" 4 BOLT CHANNEL (coupler not included)

ITEM #	POSITION	OUTER CASE	FINISH	NOTES	WT (LBS.)
8103721	Center	5 Hole Standard	Zinc		52
8105422	Center	50° Mount	Primed		52

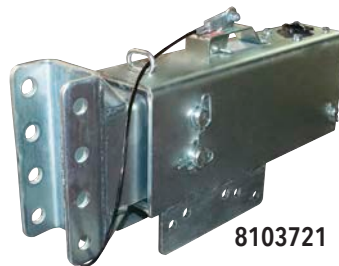

8103721

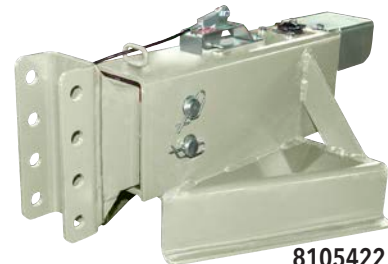

8105422

MANUAL LOCKOUT KIT

DA10	Manual Lockout Kit	6375
------	--------------------	------

BYPASS SOLENOID KITS FOR DRUM BRAKES

5752	DA10	Solenoid Kit
5837	DA10	Inline Solenoid Kit with Cover Plate

Custom mounting available upon request (50 quantity minimum)

ACTUATORS

**DRUM
BRAKE**

DA10

**12,500 LB.
G.V.W.R.**

FLAT PLATE (coupler not included)

ITEM #	POSITION	OUTER CASE	FINISH	WT (LBS.)
8101952	Center	Weld On Angle Mounts	Primed	58

2 5/16" EZ-LATCH

ITEM #	POSITION	OUTER CASE	FINISH	NOTES	WT (LBS.)
8101801	Center	5 Hole Standard	Zinc		55
8101802	Center	5 Hole Standard	Primed		56
8102511	Down	5 Hole Standard	Zinc		54
8103102	Center	Weld On	Primed		49

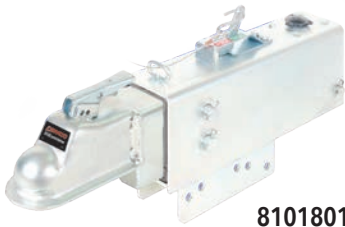

12" 6 BOLT CHANNEL (coupler not included)

ITEM #	POSITION	OUTER CASE	FINISH	NOTES	WT (LBS.)
8102131	Down	5 Hole Standard	Zinc		55
8101532	Down	3 Hole Standard	Primed		54
8101541	Down	3 Hole Standard	Zinc	.031 orifice	50
8101522	Center	Weld On	Primed		53
8101523	Center	Weld On	Black		53
8103432	Down	Weld On	Primed		53

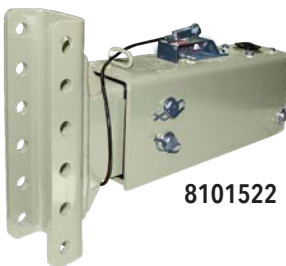
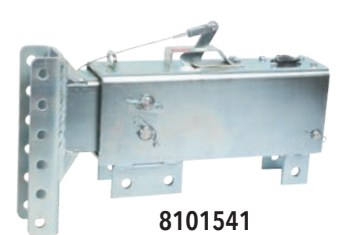
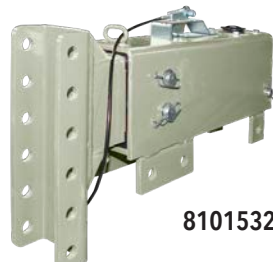
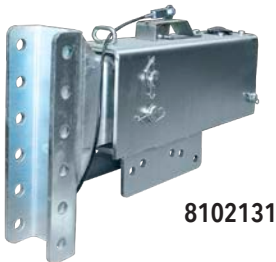

DISC BRAKE CONVERSION

CONVERTS ANY DRUM BRAKE ACTUATOR TO DISC

ITEM #	DESCRIPTION	WT (LBS.)
6114	Changes standard master cylinder to large bore disc brake with a bypass. Installation includes replacement push rod (factory installed only)	2

8" 4 BOLT CHANNEL (coupler not included)

ITEM #	POSITION	OUTER CASE	FINISH	NOTES	WT (LBS.)
8101021	Center	5 Hole Standard	Zinc		52
8101022	Center	5 Hole Standard	Primed		52
8101023	Center	5 Hole Standard	Black		52
8101031	Down	5 Hole Standard	Zinc		52
8101038	Down	5 Hole Standard	Black		52
8101042	Up	5 Hole Standard	Primed		52
8104821	Center	3 Hole Standard	Zinc		49
8104831	Down	3 Hole Standard	Zinc		49
8102222	Center	50° Mount	Primed		62
8102232	Down	50° Mount	Primed		62
8100122	Center	Angle Mount	Primed		50
8101222	Center	Weld On	Primed		50
8101232	Down	Weld On	Primed		50

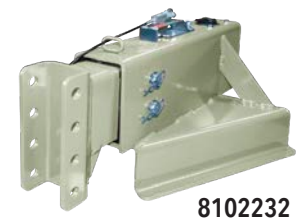
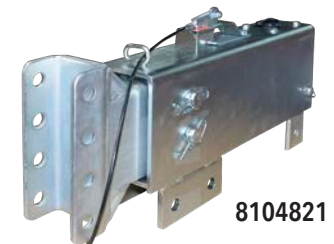
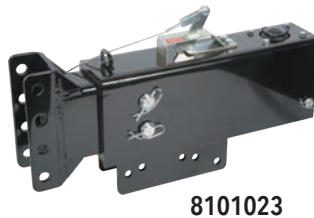
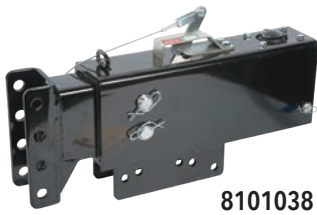
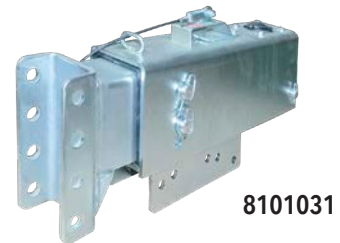
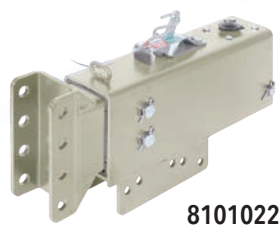
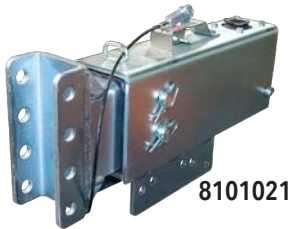

**DRUM
BRAKE**

DA10

**12,500 LB.
G.V.W.R.**

ACTUATORS

DISC BRAKE

DA16

**16,000 LB.
G.V.W.R.**

2 5/16" EZ-LATCH

ITEM #	POSITION	OUTER CASE	FINISH	NOTES	WT (LBS.)
8164311	Down	5 Hole	Zinc	Bypass	87
8464311	Down	5 Hole	Zinc	Inline with Manual Lockout	87
8465311	Down	5 Hole	Zinc	w/ Manual Lockout, Inline Solenoid, and Custom Solenoid Cover	87



8164311

MANUAL LOCKOUT KIT

DA16	Manual Lockout Kit	6422
------	--------------------	------

DISC BRAKE

DA20

**20,000 LB.
G.V.W.R.**

2 5/16" EZ-LATCH

ITEM #	POSITION	OUTER CASE	FINISH	NOTES	WT (LBS.)
8204311	Down	5 Hole	Zinc	Bypass	71
8204702	Center	Weld On	Primed	Bypass	70
8424311	Down	5 Hole	Zinc	Inline with Manual Lockout	71
8425311	Center	Weld On	Primed	w/ Manual Lockout, Inline Solenoid, and Custom Solenoid Cover	70



8204311

8" 4 BOLT CHANNEL (coupler not included)

ITEM #	POSITION	OUTER CASE	FINISH	NOTES	WT (LBS.)
8202031	Center	5 Hole	Plated		59
8205222	Center	50° Mount	Primed	Bypass	80

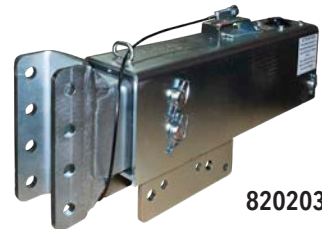

8202031

2 5/16" EZ-LATCH

ITEM #	POSITION	OUTER CASE	FINISH	NOTES	WT (LBS.)
8203102	Center	Weld On Tube Mount	Primed		70
8204011	Down	5 Hole	Zinc		70

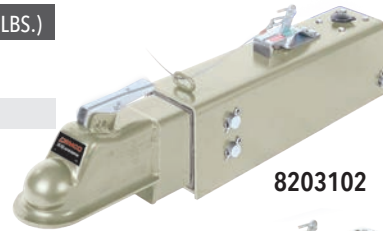

8203102

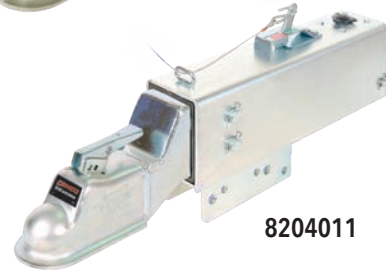

8204011

8" 4 BOLT CHANNEL (coupler not included)

ITEM #	POSITION	OUTER CASE	FINISH	NOTES	WT (LBS.)
8202022	Center	Weld On	Primed		59
8202023	Center	Weld On	Black		59
8202032	Down	Weld On	Primed		59
8202042	Up	Weld On	Primed		59
8202122	Center	Weld On Tube Mount	Primed		70
8202131	Center	5 Hole	Plated		59
8202132	Down	Weld On Tube Mount	Primed		70
8202222	Center	50° Mount	Primed		80
8202232	Down	50° Mount	Primed		80
8205322	Center	50° Mount	Primed	Inline	80



8202022

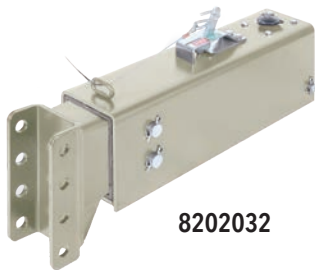

8202032



8202042

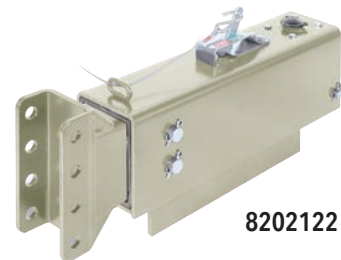

8202122

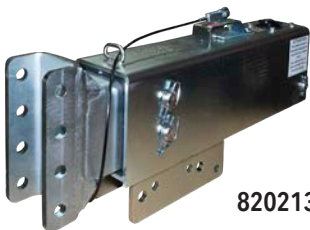

8202131

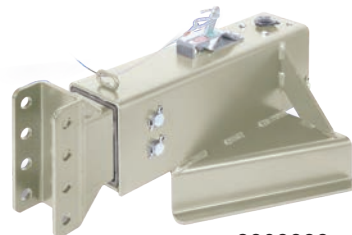

8202222

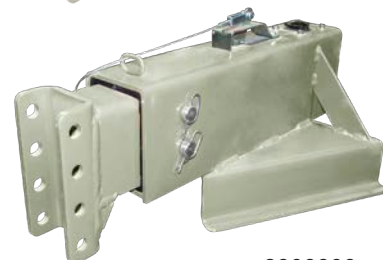

8202232

INLINE SOLENOID KITS FOR DRUM BRAKES

5838	DA20	Inline Solenoid Kit with Cover Plate
------	------	--------------------------------------

ACTUATORS

**DRUM
BRAKE**

DA20

**20,000 LB.
G.V.W.R.**

FLAT PLATE *(coupler not included)*

ITEM #	POSITION	OUTER CASE	FINISH	NOTES	WT (LBS.)
8202052	Center	Weld On	Primed		62
8202152	Center	Weld On Tube Mount	Primed		70



8202052

NO CHANNEL SLIDER *(coupler not included)*

ITEM #	POSITION	OUTER CASE	FINISH	NOTES	WT (LBS.)
8202932	Bare	Weld On	Primed		69



8202932

12" 6 BOLT CHANNEL *(coupler not included)*

ITEM #	POSITION	OUTER CASE	FINISH	NOTES	WT (LBS.)
8202521	Center	3 Hole Standard	Zinc		72
8202522	Center	3 Hole Standard	Primed		72
8202531	Down	3 Hole Standard	Zinc		72
8202532	Down	3 Hole Standard	Primed		72
8203322	Center	Weld On	Primed		62
8203332	Down	Weld On	Primed		62
8204333	Down	5 Hole	Black		72

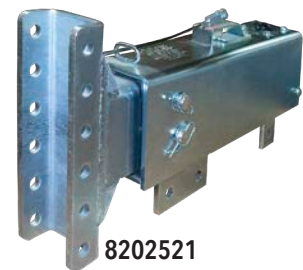

8202521



8202522



8203332



8204333

MANUAL LOCKOUT KIT

DA20	Manual Lockout Kit	6422
------	--------------------	------

DISC BRAKE CONVERSION

CONVERTS ANY DRUM BRAKE ACTUATOR TO DISC

ITEM #	DESCRIPTION	WT (LBS.)
6115	DA20 Changes standard master cylinder to large bore disc brake with a bypass. Installation includes replacement push rod (factory installed only)	2

UNASSEMBLED ACTUATOR KITS DA91, DA10, and DA20

These actuators come unassembled for weld on applications. Parts come boxed for assembly after welding and paint.

ITEM #	POSITION	OUTER CASE	FINISH	NOTES	SAME AS	WT (LBS.)
6106	8" Center	Weld On	None	DA91 Knocked Down	8759922	37
6050	8" Center	Weld On	None	DA10 Knocked Down	8101222	47
5930	12" Center	Weld On	None	DA10 Knocked Down	8101522	50
6049	8" Center	Weld On	None	DA20 Knocked Down	8202022	56
6086	12" Center	Weld On	None	DA20 Knocked Down	8203322	60
5947	12" Down	Weld On	None	DA20 Knocked Down	8203332	60
5541	Bare	Weld On	None	DA20 Knocked Down	8202932	50
6171	8" Up	Weld On	None	DA91 Knocked Down	8759942	30
6185	8" Up	Weld On	None	DA10 Knocked Down	8101042	30
6186	Flat Plate	Weld On	None	DA20 Knocked Down	8202052	62



ACTUATOR REPLACEMENT COMPONENTS FOR DISC AND DRUM BRAKES

Brake Master Cylinder
(Drum) 5650
(Disc) 5672



Brake Master Cylinder With Inline Solenoid
(Drum) 5921
(Disc) 5919



Brake Master Cylinder With Bypass Solenoid
(Drum) 5920
(Disc) 5918



Large Bore Aluminum Disc Brake Master Cylinder with Bypass Solenoid
(Disc) 6113



Large Bore Aluminum Disc Brake Master Cylinder with Inline Solenoid
(Disc) 6379



Replacement Inline Solenoid
11993



Replacement Bypass Solenoid
(Bypass Solenoid) 05561
(Bypass Solenoid Kit) 5404



Slide Kits
5942 DA91
5943 DA10
5944 DA16/DA20



COUPLERS

DEMCO®

EZ-Latch Coupler

STEP 1



The EZ-Latch coupler remains in its locked position. No need to open the coupler. Simply back under the coupler and start lowering it onto the ball.

STEP 2



The coupler will automatically open to accept the hitch ball into the coupler socket.

STEP 3



Once the trailer is completely lowered, the coupler will automatically lock around the hitch ball.

Demco's exclusive EZ-Latch coupler design automatically latches when dropped onto a hitch ball.

- **SAFETY** - All Demco EZ-Latch couplers exceed all required SAE J684 safety standards without the use of a safety pin.
- **SECURITY** - Never forget to latch your coupler again. Let our EZ-Latch system bring you peace of mind when hooking up your next trailer.
- **MAINTENANCE FRIENDLY** - The EZ-Latch System is a maintenance-free system. NO grease or adjustments needed.
- **VARIETY** - EZ-Latch couplers are available in a variety of styles and weight ratings: channel mount, tube mount, and A-frame from 10,000 to 21,000 lb. G.V.W.R.
- **LIFETIME WARRANTY** - Limited Lifetime Warranty on the composite handle to the original owner

The EZ-Latch coupler is offered in an array of different hitch mounts in both 2" and 2 5/16" ball coupler sizes

MOUNTING CONFIGURATIONS INCLUDE:

- Weld on or bolt on 3" tongue tube
- Weld on or bolt on A-frame
- Bolt-on adjustable height channel mounts

See how the EZ-Latch coupler works:



Scan the QR code using your phone's camera

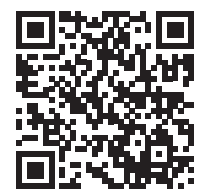

Demco 2" and 2 5/16" EZ-Latch Couplers are Patent #76906732

2" Tube Mount

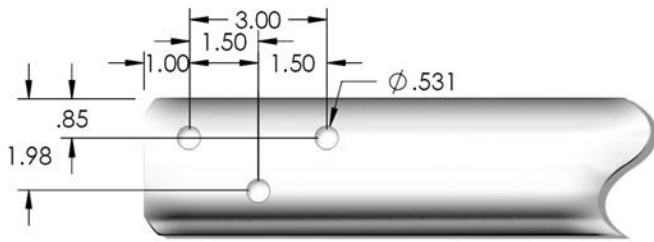

2" & 2 5/16" 50° A-Frame Mount

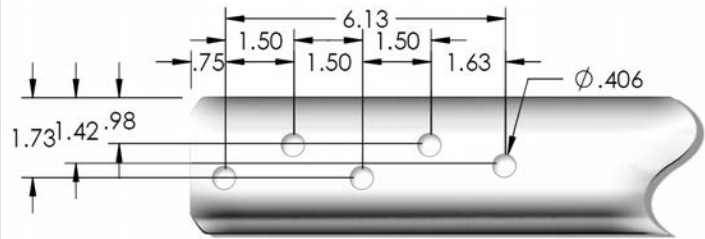

2" & 2 5/16" Tube Mount

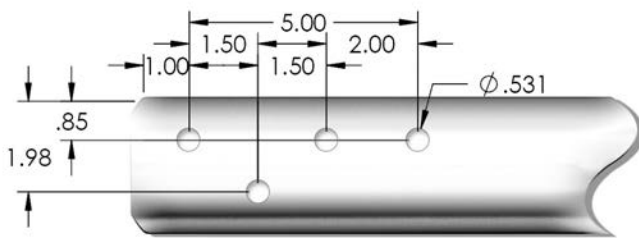

2" & 2 5/16" A-Frame

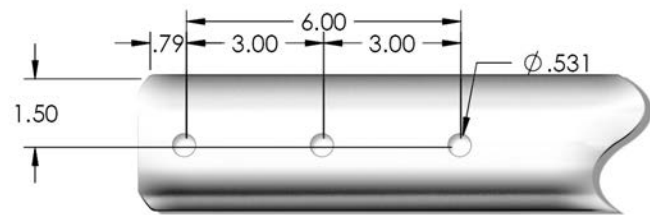

Flat Mount

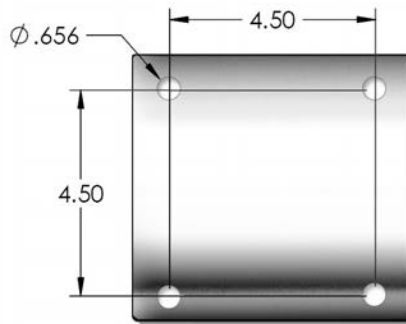

Channel Mount

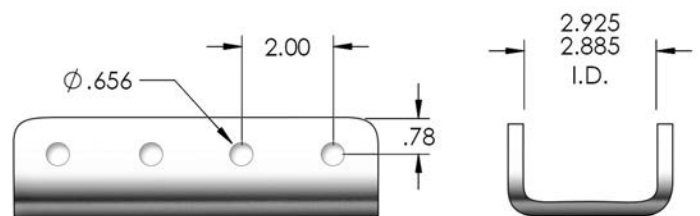

Trimax Adjustable Coupler Lock



16244

7/8", 2-1/2" to 3-1/2" Spans

- Triple Plated Chrome Finish

DEMCO FINISHES



Silver: -52
Powder coated

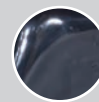

Black: -81
Powder coated



Zinc: -95
Plated zinc



Primed: -97
Powder coated

COUPLERS

**7000 LB.
G.V.W.R.**

2" CHANNEL MOUNT

ITEM #	FINISH	DESCRIPTION	WT (LBS.)
05823-81	Black	Slide-lok, bolt on channel	12
05823-95	Zinc	Slide-lok, bolt on channel	12
05823-97	Primed	Slide-lok, bolt on channel	12



05823-95



05823-81

**10,000 LB.
G.V.W.R.**

2" CHANNEL MOUNT

ITEM #	FINISH	DESCRIPTION	WT (LBS.)
16825-52	Silver	EZ-Latch composite handle, 2 bolt on	12
16825-81	Black	EZ-Latch composite handle, 2 bolt on	12
16825-95	Zinc	EZ-Latch composite handle, 2 bolt on	12
16825-97	Primed	EZ-Latch composite handle, 2 bolt on	12



16825-81

**10,000 LB.
G.V.W.R.**

2" COUPLER/CHANNEL KITS

ITEM #	DESCRIPTION	WT (LBS.)
6451-81	Coupler with hardware	
6367-81	Coupler, channel, and hardware	

**7000 LB.
G.V.W.R.**

2" TUBE MOUNT

ITEM #	FINISH	DESCRIPTION	WT (LBS.)
15945	Zinc	EZ-Latch composite handle, 3 hole bolt on	8



15945

6378	Hardware Kit for 16825 (contains 2 GR8 5/8" bolts, 2 washers, 2 lock nuts)	2
6166	Channel Mount Coupler Hardware Kit (contains 4 GR5 5/8" bolts, 4 washers, 4 lock nuts)	2

**10,000 LB.
G.V.W.R.**

2" TUBE MOUNT

ITEM #	FINISH	DESCRIPTION	WT (LBS.)
17427-52	Silver	4 hole bolt on	8
17427-81	Black	4 hole bolt on	8
17427-95	Zinc	4 hole bolt on	8
17429-52	Silver	4 hole bolt on with chain anchor	8
17429-81	Black	4 hole bolt on with chain anchor	8
17429-95	Zinc	4 hole bolt on with chain anchor	8
17436-52	Silver	EZ-Latch composite handle, 3 hole bolt on	7
17436-81	Black	EZ-Latch composite handle, 3 hole bolt on	7
17436-95	Zinc	EZ-Latch composite handle, 3 hole bolt on	7
17961	Raw	EZ-Latch composite handle, weld on	7
17961-97	Primed	EZ-Latch composite handle, weld on	7



17427-95



17429-81



17436-95



17961-97

2" FLAT MOUNT

ITEM #	FINISH	DESCRIPTION	WT (LBS.)
17836-52	Silver	2" Cast Flat Mount	
17836-81	Black	2" Cast Flat Mount	
17836-95	Zinc	2" Cast Flat Mount	
17836-97	Primed	2" Cast Flat Mount	

2" 50° MOUNT

ITEM #	FINISH	DESCRIPTION	WT (LBS.)
16698	Raw	Cast A-frame weld on	20
16698-81	Black	Cast A-frame weld on	20
16698-97	Primed	Cast A-frame weld on	20
16854-81	Black	Cast A-frame bolt on with chain anchor	20
16854-95	Zinc	Cast A-frame bolt on with chain anchor	20
16908	Raw	Cast A-frame bolt on	20
16908-52	Silver	Cast A-frame bolt on	20
16908-81	Black	Cast A-frame bolt on	20
16908-95	Zinc	Cast A-frame bolt on	20
16908-97	Primed	Cast A-frame bolt on	20
17115	Raw	A-frame weld on without jack hole	20
17115-81	Black	A-frame weld on without jack hole	20
18185	Raw	Cast A-frame weld on	20
17816-52	Silver	Cast bolt on wide mount for prepped tube	20
17818-52	Silver	Cast bolt on narrow mount for unprepped tube	20



16698-81



16854-81



17115



NOTE: All Demco 2" EZ-Latch Couplers are Patent #76906732.

COUPLERS

2" COUPLER REPAIR KITS

ITEM #	DESCRIPTION	WT (LBS.)
5696	Lever lock coupler repair kit 6000 lb. non EZ-Latch	2
5876	EZ-Latch coupler repair kit 10,000 lb. metal handle	2
6109	EZ-Latch coupler repair kit 10,000 lb. composite handle	2
6288	EZ-Latch coupler repair kit for cast coupler	
6317	Composite handle only	1

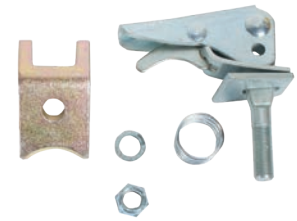

5696



5876



6109



6288



6317

12,500 LB.
G.V.W.R.

2 5/16" CHANNEL MOUNT

ITEM #	DESCRIPTION	WT (LBS.)
05557-95	2 5/16" Slide-lok, 12,500 lb. G.V.W.R. capacity, bolt on channel	12
05557-81	2 5/16" Slide-lok, 12,500 lb. G.V.W.R. capacity, bolt on channel	12



05557-95



05557-81

21,000 LB.
G.V.W.R.

2 5/16" CHANNEL MOUNT CAST COUPLER

ITEM #	FINISH	DESCRIPTION	
14040-52	Silver	EZ-Latch composite handle, bolt on	9
14040-81	Black	EZ-Latch composite handle, bolt on	9
14040-95	Zinc	EZ-Latch composite handle, bolt on	9
14040-97	Primed	EZ-Latch composite handle, bolt on	9
15791-52	Silver	EZ-Latch metal handle, bolt on	9
15791-81	Black	EZ-Latch metal handle, bolt on	9
15791-95	Zinc	EZ-Latch metal handle, bolt on	9
15791-97	Primed	EZ-Latch metal handle, bolt on	9



14040-81



15791-81

2 5/16" COMBO COUPLERS AND CHANNELS

ITEM #	DESCRIPTION	WT (LBS.)
6301-81	Coupler/hardware kit	
6443-81	Coupler/hardware kit	
6461-81	Coupler, hardware, and channel kit	

**18,000 LB.
G.V.W.R.**

14040 COUPLER CHANNELS

ITEM #	FINISH	DESCRIPTION	WT (LBS.)
6124-52	Silver	EZ-Latch, channel mount 12" 6 hole .375" channel without bolts	18
6124-81	Black	EZ-Latch, channel mount 12" 6 hole .375" channel without bolts	18
6124-95	Zinc	EZ-Latch, channel mount 12" 6 hole .375" channel without bolts	18
6124-97	Primed	EZ-Latch, channel mount 12" 6 hole .375" channel without bolts	18
6167-81	Black	EZ-Latch, channel mount 8" 4 hole without bolts	18
6167-97	Primed	EZ-Latch, channel mount 8" 4 hole without bolts	18



**20,000 LB.
G.V.W.R.**

15791 CAST COUPLER WITH CHANNEL

ITEM #	DESCRIPTION	WT (LBS.)
6178-81	2 5/16" EZ-Latch, channel mount 8" 4 hole	18
6178-97	2 5/16" EZ-Latch, channel mount 8" 4 hole	18
6184-81	2 5/16" EZ-Latch, channel mount 12" 6 hole	16
6166	Channel Mount Coupler Hardware Kit (contains 4 GR5 5/8" bolts, 4 washers, 4 lock nuts)	2



14040 COUPLER CHANNELS

ITEM #	FINISH	DESCRIPTION	WT (LBS.)
6125-52	Silver	EZ-Latch, channel mount 12" 6 hole .5" channel with bolts and gussets	23
6125-81	Black	EZ-Latch, channel mount 12" 6 hole .5" channel with bolts and gussets	23
6125-95	Zinc	EZ-Latch, channel mount 12" 6 hole .5" channel with bolts and gussets	23
6125-97	Primed	EZ-Latch, channel mount 12" 6 hole .5" channel with bolts and gussets	23
6312		Coupler/hardware kit	



**21,000 LB.
G.V.W.R.**

15791 CAST COUPLER WITH CHANNEL

ITEM #	DESCRIPTION	WT (LBS.)
6315-81	2 5/16" EZ-Latch, channel mount 12" 6 hole w/ hardware	23

COUPLERS

**18,000 LB.
G.V.W.R.**

2 5/16" TUBE MOUNT

ITEM #	FINISH	DESCRIPTION	WT (LBS.)
13203-52	Silver	EZ-Latch composite handle, bolt on channel	11
13203-95	Zinc	EZ-Latch composite handle, bolt on channel	11



13203-52

**21,000 LB.
G.V.W.R.**

2 5/16" TUBE MOUNT

ITEM #	FINISH	DESCRIPTION	WT (LBS.)
15931-81	Black	EZ-Latch composite handle, bolt on channel	17
15931-95	Zinc	EZ-Latch composite handle, bolt on channel	17
16080-52	Silver	EZ-Latch composite handle, 5 bolt on channel	19
16080-81	Black	EZ-Latch composite handle, 5 bolt on channel	19
16080-95	Zinc	EZ-Latch composite handle, 5 bolt on channel	19
17832-52	Silver	EZ-Latch composite handle, 5 bolt on offset	19
17832-95	Zinc	EZ-Latch composite handle, 5 bolt on offset	19
17963	Raw	EZ-Latch composite handle, weld on	19
17963-97	Primed	EZ-Latch composite handle, weld on	19



15931-95



16080-95

**21,000 LB.
G.V.W.R.**

2 5/16" FLAT MOUNT

ITEM #	FINISH	DESCRIPTION	WT (LBS.)
15923-81	Black	EZ-Latch composite handle, flat mount 5/8" holes	13.5
15923-95	Zinc	EZ-Latch composite handle, flat mount 5/8" holes	13.5
15923-97	Primed	EZ-Latch composite handle, flat mount 5/8" holes	13.5
16759-81	Black	EZ-Latch composite handle, flat mount 3/4" holes	13.5
16759-95	Zinc	EZ-Latch composite handle, flat mount 3/4" holes	13.5
16759-97	Primed	EZ-Latch composite handle, flat mount 3/4" holes	13.5



15923-81



16759-81

**25,000 LB.
G.V.W.R.**

2 5/16" FLAT MOUNT

ITEM #	FINISH	DESCRIPTION	WT (LBS.)
17415-52	Silver	EZ-Latch composite handle flat mount 3/4" holes	13.5
17415-81	Black	EZ-Latch composite handle flat mount 3/4" holes	13.5
17415-95	Zinc	EZ-Latch composite handle flat mount 3/4" holes	13.5
17415-97	Primed	EZ-Latch composite handle flat mount 3/4" holes	13.5



17415-81

COUPLERS

2 5/16" 32° / 50° MOUNT

ITEM #	FINISH	DESCRIPTION	WT (LBS.)
16680-52	Silver	50°, EZ-Latch composite handle, A-frame bolt on with jack hole and chain anchors	17
16680-95	Zinc	50°, EZ-Latch composite handle, A-frame weld on with jack hole and chain anchors	17
17106	Raw	50°, EZ-Latch composite handle, A-frame bolt on with jack hole	17
17106-81	Black	50°, EZ-Latch composite handle, A-frame bolt on with jack hole	17
17106-95	Zinc	50°, EZ-Latch composite handle, A-frame bolt on with jack hole	17
17106-97	Primed	50°, EZ-Latch composite handle, A-frame bolt on with jack hole	17
17063	Raw	50°, EZ-Latch composite handle, A-frame weld on with jack hole	12
17063-81	Primed	50°, EZ-Latch composite handle, A-frame weld on with jack hole	12
17063-97	Primed	50°, EZ-Latch composite handle, A-frame weld on with jack hole	12
17500	Raw	50°, EZ-Latch composite handle, A-frame bolt on with jack hole, cast	17
17500-81	Black	50°, EZ-Latch composite handle, A-frame bolt on with jack hole, cast	17
17500-52	Silver	50°, EZ-Latch composite handle, A-frame bolt on with jack hole, cast	17
17500-95	Zinc	50°, EZ-Latch composite handle, A-frame bolt on with jack hole, cast	17
17551	Raw	50°, EZ-Latch composite handle, A-frame weld on with jack hole, full body	17
17551-97	Primed	50°, EZ-Latch composite handle, A-frame weld on with jack hole, full body	17
17820-52	Silver	Cast bolt on wide mount for prepped tube	17
17822-52	Silver	Cast bolt on narrow mount for unprepped tube	17
18171-52	Silver	Cast 32°, A-frame bolt on coupler with chain anchors. Bolt hole spacing is 4" center to center.	17
18319	Raw	Cast 32°, EZ-Latch composite handle, A-frame weld on.	17
18319-52	Silver	Cast 32°, EZ-Latch composite handle, A-frame weld on.	17
18319-81	Black	Cast 32°, EZ-Latch composite handle, A-frame weld on.	17
18319-97	Primed	Cast 32°, EZ-Latch composite handle, A-frame weld on.	17
18429	Raw	Cast 50°, A-frame weld on without jack hole	17



16680-52



17106-95



17063



17500



17551



18171-52

**21,000 LB.
G.V.W.R.**

2 5/16" 50° MOUNT

ITEM #	FINISH	DESCRIPTION	WT (LBS.)
16637-52	Silver	EZ-Latch composite handle, A-frame weld on with jack hole	12
16637-81	Black	EZ-Latch composite handle, A-frame weld on with jack hole	12
16637-97	Primed	EZ-Latch composite handle, A-frame weld on with jack hole	12
16637	Raw	EZ-Latch composite handle, A-frame weld on with jack hole	12



16637

**12,500 LB.
G.V.W.R.**

COUPLERS

2 5/16" COUPLER REPAIR KITS

ITEM #	DESCRIPTION	WT (LBS.)
5817	EZ-Latch coupler repair kit metal handle	2
6008	EZ-Latch coupler repair kit composite handle	2
6288	EZ-Latch coupler repair kit for cast coupler	2
6317	Composite handle only	1



GOOSENECK COUPLER

ITEM #	DESCRIPTION	WT (LBS.)
18332	Cast gooseneck coupler head assembly raw	
18332-81	Cast gooseneck coupler head assembly black	
17839-81	Square gooseneck inner assembly black	
6387	Square gooseneck outer assembly raw	
6394	Round gooseneck inner assembly black	
6388	Round gooseneck outer assembly raw	



DEMCO GOOSENECK COUPLER LOCK

ITEM #	DESCRIPTION	WT (LBS.)
17654-81	Gooseneck coupler lock	

30,000 LB.
G.V.W.R.

25,000 LB.
G.V.W.R.

42,000 LB.
G.V.W.R.

PINTLE RING

PINTLE RING CHANNEL MOUNT

ITEM #	FINISH	DESCRIPTION	WT
09557-52	Silver	3" ID, 6" OD, 25,000 lb. bolt on channel	13
09557-81	Black	3" ID, 6" OD, 25,000 lb. bolt on channel	13
09557-95	Zinc	3" ID, 6" OD, 25,000 lb. bolt on channel	13
09557-97	Primed	3" ID, 6" OD, 25,000 lb. bolt on channel	13
6135-52	Silver	3" ID, 6" OD, bolt on channel with 12" 20,000 lb. channel and hardware	22
6135-81	Black	3" ID, 6" OD, bolt on channel with 12" 20,000 lb. channel and hardware	22
6135-95	Zinc	3" ID, 6" OD, bolt on channel with 12" 20,000 lb. channel and hardware	22
6135-97	Primed	3" ID, 6" OD, bolt on channel with 12" 20,000 lb. channel and hardware	12



PINTLE RING FLAT MOUNT

ITEM #	FINISH	DESCRIPTION	WT
17706	Raw	42K flat mount 3/4" bolts	19
17706-81	Black	42K flat mount 3/4" bolts	19



COUPLERS

CHANNEL MOUNT

ITEM #	FINISH	DESCRIPTION	WT
13867-52	Silver	3" tube channel mount bolt on 12,000 lb. G.V.W.R. capacity	16
13867-81	Black	3" tube channel mount bolt on 12,000 lb. G.V.W.R. capacity	16
13867-95	Zinc	3" tube channel mount bolt on 12,000 lb. G.V.W.R. capacity	16
13867-97	Primed	3" tube channel mount bolt on 12,000 lb. G.V.W.R. capacity	16
15349-52	Silver	A-frame channel mount bolt on without jack hole 14,000 lb. G.V.W.R. capacity	20
15795-52	Silver	A-frame channel mount bolt on with jack hole 14,000 lb. G.V.W.R. capacity	20
15974-52	Silver	A-frame channel mount without jack hole channel down, 14,000 lb. G.V.W.R. capacity	20
18441-52	Silver	A-frame channel mount without jack hole channel center, 14,000 lb G/V.W.R. capacity	20



**12,000 LB.
AND
14,000 LB.
G.V.W.R.**

CLEVIS CHANNEL MOUNT

ITEM #	FINISH	DESCRIPTION	WT (LBS.)
05593-81	Black	Clevis, 10,000 lb. G.V.W.R. capacity, bolt on channel	11
05593-95	Zinc	Clevis, 10,000 lb. G.V.W.R. capacity, bolt on channel	11
05593-97	Primed	Clevis, 10,000 lb. G.V.W.R. capacity, bolt on channel	11
12676-81	Black	Clevis, 20,000 lb. G.V.W.R. capacity, bolt on channel	12
12676-95	Zinc	Clevis, 20,000 lb. G.V.W.R. capacity, bolt on channel	12

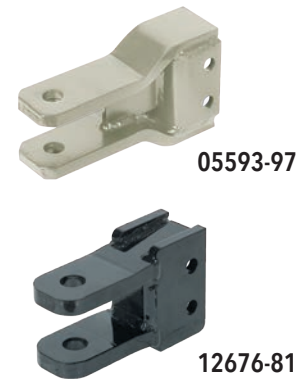

**10,000 LB.
AND
20,000 LB.
G.V.W.R.**

CHANNELS

WELD-ON CHANNEL BRACKETS 8"

4 Hole (Hole spacing 2" centers) 8" over-all length.

ITEM #	WT (LBS.)	MIN-MAX ID	CHANNEL THICKNESS	WEIGHT RATING	WT (LBS.)
55342	2.885"-2.925"	.25"		7,500 lbs.	4
55289	2.885"-2.925"	.313"		14,000 lbs.	5
57362	2.885"-2.925"	.375"		20,000 lbs.	5
66736	2.885"-2.925"	.5" Grade 80		21,000 lbs.	5



**7500 LB.
THROUGH
21,000 LB.
G.V.W.R.**

WELD-ON CHANNEL BRACKETS 12"

6 Hole (Hole spacing 2" centers) 12" over-all length.

ITEM #	WT (LBS.)	MIN-MAX ID	CHANNEL THICKNESS	WEIGHT RATING	WT (LBS.)
59601	2.885"-2.925"	.313"		14,000 lbs.	7
59602	2.885"-2.925"	.375"		20,000 lbs.	8
66134	2.885"-2.925"	.5"		21,000 lbs.	9



SAFETY CABLES AND JACKS

7,000 LB.
TO
14,000 LB.

SAFETY CABLES

ITEM #	CAPACITY	LENGTH	COLOR
17639	7K	42" long	Clear
17640	7K	48" long	Clear
17641	7K	54" long	Clear
17642	7K	60" long	Clear
17643	9.8K	42" long	Black
17644	9.8K	48" long	Black
17645	9.8K	54" long	Black
17646	9.8K	60" long	Black
17647	14K	42" long	Blue
17648	14K	48" long	Blue
17649	14K	54" long	Blue
17650	14K	60" long	Blue



JACKS

ITEM #	DESCRIPTION	GVWR	COATING	DIM RET/EXT	TUBE
16730	Top wind side mount swivel	2000 lbs.	Plated/Plated	9" / 18"	Welded Foot
17238	Top wind pipe mount	2000 lbs.	Black/Plated	11" / 21"	Welded Foot
17240	Top wind A-frame	5000 lbs.	Black/Plated	8.25" / 24.25"	Open Tube
17241	Side wind pipe mount	5000 lbs.	Black/Plated	10" / 20"	Welded Foot
17245	Side wind weld-on drop leg	7000 lbs.	Black/Plated	24" / 53"	Welded Foot
17247	Top wind weld-on drop leg	7000 lbs.	Black/Plated	24" / 53"	Welded Foot

18186 - Pipe (can be used with * above)



16730

17238

17240

17241

17245

17247

TONGUES FOR AGRICULTURAL RUNNING GEARS OR DROP TONGUE TRAILERS

12 TON G.V.W.R. BOLT-ON

ITEM #	TYPE	DESCRIPTION	WT (LBS.)
07686	DA12	Painted black, agricultural gear actuator	23

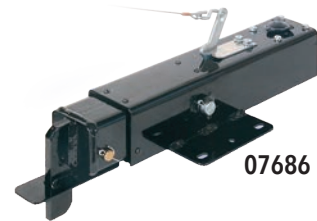

07686

24 TON G.V.W.R. A-FRAME

Telescoping A-Frame tongues - 86" overall length, 17.75" Telescope 2" mounting tabs needed 31.25" on center.

ITEM #	TYPE	DESCRIPTION	WT (LBS.)
6133-81	A-Frame	Tongue Gloss Black Assembled with Brakes, Clevis, A-Frame	260
6133-71	A-Frame	Tongue Gloss Red Assembled with Brakes, Clevis, A-Frame	260
6134-81	A-Frame	Tongue Gloss Black Assembled without Brakes, Clevis, A-Frame	235
6134-71	A-Frame	Tongue Gloss Red Assembled without Brakes, Clevis, A-Frame	235



6133-81



6134-71

24 TON G.V.W.R.

Telescoping tongues - 77.5" overall length 17.75 telescope.

ITEM #	TYPE	DESCRIPTION	WT (LBS.)
5730	Tongue	Raw tongue assembly without brakes, clevis, no mounts	143
6030	Tongue	Raw tongue unassembled without brakes, clevis, no mounts	143
5597	Tongue	Raw tongue assembly with brakes, clevis, no mounts	165
6029	Tongue	Raw tongue unassembled with brakes, clevis, no mounts	167



5730



5597

HYDRAULIC BRAKE ASSEMBLIES

10" FREE BACKING BRAKES

Features a "fall-away" shoe to reduce drag when backing up. Requires periodic manual adjustment. Marine cluster includes a galvanized back plate, stainless steel springs, plated wheel cylinder, and riveted marine brake shoe.

PRODUCT	RIGHT#	LEFT#	BOLT HOLE PATTERN	WT (LBS.)
Marine	SB40715M	SB40716M	4" on 4"	10

PRODUCT	TYPE	DESCRIPTION
Shoe Kit	07812	2 Front - 2 Rear



Reverse Braking - Minimal
Axle Rating - 3500 lbs.
Wheel Size - 13 - 15"

10" UNI-SERVO BRAKES

Provides 20% braking in reverse and requires periodic manual adjustment. The marine cluster features a galvanized back plate, stainless steel springs, a plated wheel cylinder, and riveted marine brake shoe.

PRODUCT	RIGHT#	LEFT#	BOLT HOLE PATTERN	WT (LBS.)
Marine	SB18787M	SB18788M	4" on 4"	10

PRODUCT	TYPE	DESCRIPTION
Shoe Kit	07811	2 Front - 2 Rear



Reverse Braking - 15 - 20%
Axle Rating - 3500 lbs.
Wheel Size - 13 - 15"

10" DUO-SERVO BRAKES

Applies equal braking in forward and reverse, ideal for industrial use. Requires manual adjustment. Features a galvanized back plate, stainless steel springs, a plated wheel cylinder, and riveted marine brake shoe.

PRODUCT	RIGHT#	LEFT#	BOLT HOLE PATTERN	WT (LBS.)
Marine	SB18793M	SB18794M	4" on 4"	9.2

PRODUCT	TYPE	DESCRIPTION
Shoe Kit	07811	2 Front - 2 Rear



Reverse Braking - 100%
Axle Rating - 3500 lbs.
Wheel Size - 13 - 15"

12" FREE BACKING BRAKES

Minimal reverse braking, 5,200 lb axle rating. Wheel size: 14.5" - 16". Features a galvanized back plate, stainless steel springs, plated wheel cylinder, and riveted marine brake shoe.

PRODUCT	RIGHT#	LEFT#	BOLT HOLE PATTERN	WT (LBS.)
Marine	SB42028M	SB42029M	5 on 3.875"	19

PRODUCT	TYPE	DESCRIPTION
Shoe Kit	07814	2 Front - 2 Rear



12" UNI-SERVO BRAKES

15-20% reverse braking, 5,200 lb axle rating. Wheel size: 14.5" - 16". Includes galvanized back plate, stainless steel springs, plated wheel cylinder, and riveted marine brake shoe.

PRODUCT	RIGHT#	LEFT#	BOLT HOLE PATTERN	WT (LBS.)
Marine	SB23510M	SB23511M	5 on 3.875"	19

PRODUCT	TYPE	DESCRIPTION
Shoe Kit	07813	2 Front - 2 Rear



HYDRAULIC BRAKE ASSEMBLIES

DRUMS FOR BRAKE ASSEMBLIES

10" BRAKE DRUMS

ITEM#	DICO ITEM#	# OF BOLTS	BOLT HOLE DIA.	BOLT CIRCLE DIA.	PILOT HOLE DIA.	STYLE	WT (LBS.)
11777	NA	5	1/2"	5 1/2"	4"	A	12



12" BRAKE DRUMS

ITEM#	DICO ITEM#	# OF BOLTS	BOLT HOLE DIA.	BOLT CIRCLE DIA.	PILOT HOLE DIA.	STYLE	WT (LBS.)
13717	NA	6	5/8"	5 1/2"	4 3/8"	B	14

13" BRAKE CLUSTERS

Free Backing Brakes (shown)

Reverse braking - minimal. Wheel size - 16" - 22.5"

PRODUCT	RIGHT#	LEFT#	BOLT HOLE PATTERN	WT (LBS.)
Standard	01971	01970	4 on 4.813"	21

PRODUCT	TYPE	DESCRIPTION
Shoe Kit	5508	2 Front - 2 Rear



13" UNI-SERVO BRAKE CLUSTERS

Uni-Servo Brakes (shown)

Reverse braking - 15 - 20%. Wheel size - 16" - 22.5"

PRODUCT	RIGHT#	LEFT#	BOLT HOLE PATTERN	WT (LBS.)
Standard	07911	07910	4 on 4.813"	21

PRODUCT	TYPE	DESCRIPTION
Shoe Kit	5509	2 Front - 2 Rear



13" BRAKE DRUMS

ITEM#	DICO ITEM#	# OF BOLTS	BOLT HOLE DIA.	BOLT CIRCLE DIA.	PILOT HOLE DIA.	STYLE	WT (LBS.)
05353	9894	8	5/8"	8"	5 3/4"	A	20.6
07324	16964	6	17/32"	8 1/4"	6"	A	20.3
03532	18859	8	17/32"	5 1/2"	4 3/8"	B	22.5
03940	10111	6	17/32"	5 1/2"	4 3/8"	B	22.6
03941	43268	8	17/32"	5 1/2"	4 1/2"	B	21.9



13" BRAKE FLANGES

ITEM#	PLATE DIMENSIONS	PILOT HOLE	PILOT
54988	.25" X 4.25" X 4.25" - 4 ON 4.813"	21/2"	.91
60124	.25" X 4.25" X 4.25" - 4 ON 4.813"	23/4"	.91
52415	.25" X 4.25" X 4.25" - 4 ON 4.813"	3"	.84
61715	.25" X 4.25" X 4.25" - 4 ON 4.813"	31/4"	.76
59911	.25" X 4.25" X 4.25" - 4 ON 4.813"	31/2"	.65



BRAKE LINES

SINGLE SOLID AXLE KIT

ITEM #	DESCRIPTION	WT (LBS.)
6097	180" Main Line With 72" and 30" Lines	2
5402	193" Main Line With 66" and 17" Lines	2
5426	193" Main Line With 80" and 17" Lines	2
5427	193" Main Line With 72" and 17" Lines	2.5
5643	240" Main Line With 66" and 17" Lines	2.5

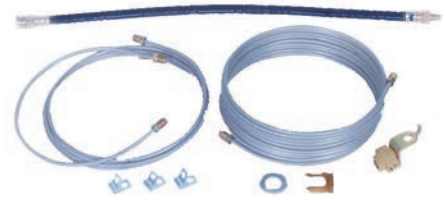

SINGLE TORSION AXLE KIT

ITEM #	DESCRIPTION	WT (LBS.)
5424	193" Main Line With 66" and 17" Lines	3



TANDEM SOLID AXLE KIT

ITEM #	DESCRIPTION	WT (LBS.)
6098	180" Main Line With 72" and 30" Lines	4
5951	193" Main Line With 80" and 17" Lines	4
5403	193" Main Line With 66" and 17" Lines	4
5428	193" Main Line With 72" and 17" Lines	4
5429	193" Main Line With 80" and 17" Lines	4
6064	193" Main Line With 66" and 4.5" Lines	4



TANDEM TORSION AXLE KIT

ITEM #	DESCRIPTION	WT (LBS.)
5425	193" Main Line With 66" and 17" Lines	4



ACTUATOR BRAKE BLEEDER

ITEM #	DESCRIPTION	WT (LBS.)
10142	Master cylinder adapter for use with power bleeder (Rubber washer included)	1
09215	Rubber washer	



10142

BRAKE LINE COMPONENTS

HARD LINES

.188 Double Flared Aluminum Galfan

ITEM #	LENGTH	DESCRIPTION	ITEM #	LENGTH	DESCRIPTION
SB5045	4 1/2		SB553	53	
11968	6		SB560	60	
SB508	8		SB566	66	
SB512	12		SB572	72	
SB517	17		SB580	80	
SB520	20		SB590	90	
09098	24		SB597	97	
SB530	30		SB5120	120	
SB532	32		07913	128	Armored Galfan Metal
SB536	36		SB5180	180	
SB537	37		SB5193	193	
SB540	40		SB5230	230	
SB541	41		SB5240	240	
SB550	50				

FLEXIBLE BRAKE HOSES

SAE 1401

ITEM #	LENGTH	DESCRIPTION	ITEM #	LENGTH	DESCRIPTION
SB7H66	7	Solid Female (2x)	09571	24	Solid Male & Female
SB7H67	7	Swivel Male & Solid Female	11876	25	Solid Female Swivel Male with 90°
10433	9	Solid Female (2x)			Line
02032	12	Solid Male & Solid Female	11714	27	Solid Male Solid Female
SB12H137	12	Solid Male & Solid Male	13858	28	Swivel Male with 90° & Solid Female
SB13H66	13	Solid Female	11738	36	Double Swivel Male With
13958	17	90° Swivel Male Ends (2x)			Coiled Armor Spring
SB18H137	18	Solid Male & Swivel Male	15009	36	Swivel Male & Solid Female
11627	18	Swivel Male with 90° & Solid Female	02034	45	Solid Female (2x)
05982	19	Solid Male & Solid Female	05979	52	Swivel Male & Swivel Male
13788	20	1/2 Solid Male & Solid Female	14006	62 45°	Elbow Male & Solid Male
SB24H137	24	Solid Male & Swivel Male			

BRAKE ACCESSORIES

ITEM #	DESCRIPTION
02549	Brake line protector rubber x .75" long
SB7764	Brake line clip
05981-95	Bracket pltd for brake line hose
01863	5/8 Rubber grommet

FITTINGS

ITEM #	DESCRIPTION
10375	Ftg .125 MPT X .125 MPT nipple
10737	Ftg Elb .125 MPT X .125 FPT 90° street elbow
10376	Ftg Elb .125 MPT X .20 HB brass
10373	Ftg Str .20 Hb X 10-32 NF Tapered brass
SB7785	Ftg Tee .188 inverted flare with bracket
SB7900	Ftg Tee .188" adapter female (2) male (1)
SBD10	Ftg union .188" female
11436	Ftg .125 MPT X .125 FPT elbow
05679	Ftg .125" MPT X .188" inverted flare

SPARE TIRE MOUNTS

STAKE POCKET MOUNT

ITEM #	FINISH	DESCRIPTION
15850-52	Silver	Stake Pocket Spare Tire Holder - Fits 2x4 standard stake pocket up to 3" deep . Accepts bolt patterns from 2.5" - 6.5"
15850-72	Black	Stake Pocket Spare Tire Holder - Fits 2x4 standard stake pocket up to 3" deep . Accepts bolt patterns from 2.5" - 6.5"
15884-52	Silver	Stake Pocket Spare Tire Holder with 4" offset - Fits standard stake pocket up to 3" deep. Accepts bolt patterns from 2.5" - 6.5"
15884-72	Black	Stake Pocket Spare Tire Holder with 4" offset - Fits standard stake pocket up to 3" deep. Accepts bolt patterns from 2.5" - 6.5"



TONGUE MOUNT

ITEM #	FINISH	DESCRIPTION
15851-52	Silver	Vertical Spare Tire Holder - Fits trailer tongues up to 4"x4". Accepts bolt patterns from 2.5"-6.5"
15851-72	Black	Vertical Spare Tire Holder - Fits trailer tongues up to 4"x4". Accepts bolt patterns from 2.5"-6.5"



SIDE MOUNTS

ITEM #	FINISH	DESCRIPTION
17808	Silver	Vertical Spare Tire Holder with wide mounting brackets
17810	Silver	Vertical Spare Tire Holder with narrow mounting brackets



JACK MOUNT

ITEM #	FINISH	DESCRIPTION
15853-52	Silver	Universal Jack Mount Spare Tire Holder - will mount opposite of bolt on swivel jacks. Accepts bolt patterns from 2.5"-6.5"
15853-72	Black	Universal Jack Mount Spare Tire Holder - will mount opposite of bolt on swivel jacks. Accepts bolt patterns from 2.5"-6.5"

Tire mounts are available in 2 FINISH options:



Silver: -52



Black Texture: -72

Canada
GWN Marketing
wayne@gwnmarketing.ca

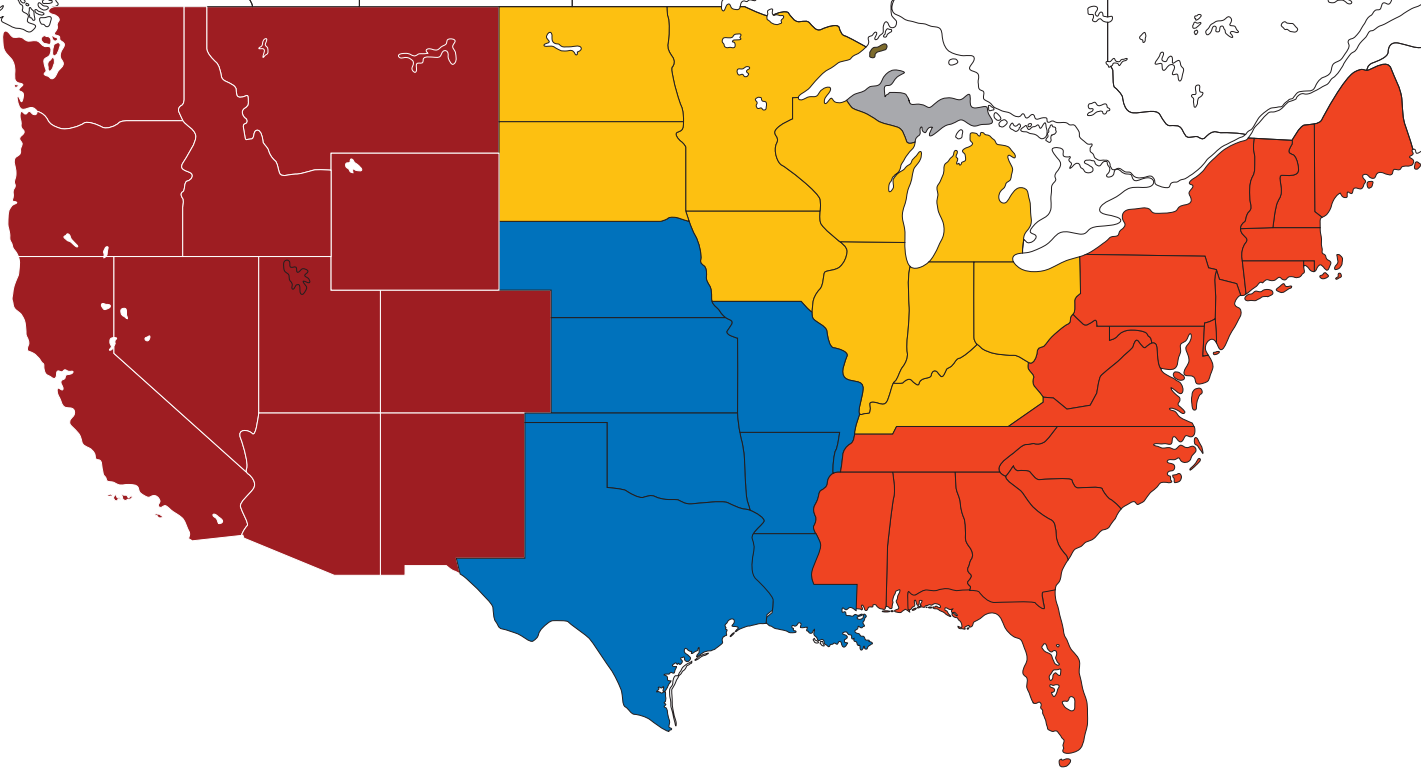

Trailer Components Sales Territory Managers

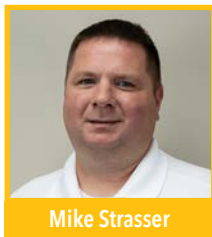

- **Mike Strasser** || Midwestern United States Territory Manager || mike.strasser@demco-products.com
- **Easton Cole** || Western United States Territory Manager || easton.cole@demco-products.com
- **Adam Ross** || Southern United States Territory Manager || adam.ross@demco-products.com
- **Craig Snider** || Eastern United States Territory Manager || craig.snider@demco-products.com

DEMCO®

Boyden

4010 320th Street
Boyden, IA 51234
Ph. 800.543.3626

Spencer

1300 38th Ave W.
Spencer, IA 51301
Ph. 800.543.3626

www.demco-products.com • 800-543-3626

www.demco-products.com

DEMCO is a registered trademark of Dethmers Manufacturing Company

